

**SECTION A-A
SCALE 1 : 5**

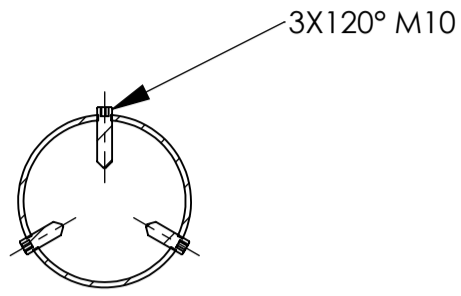

**DETAIL B
SCALE 1 : 5**

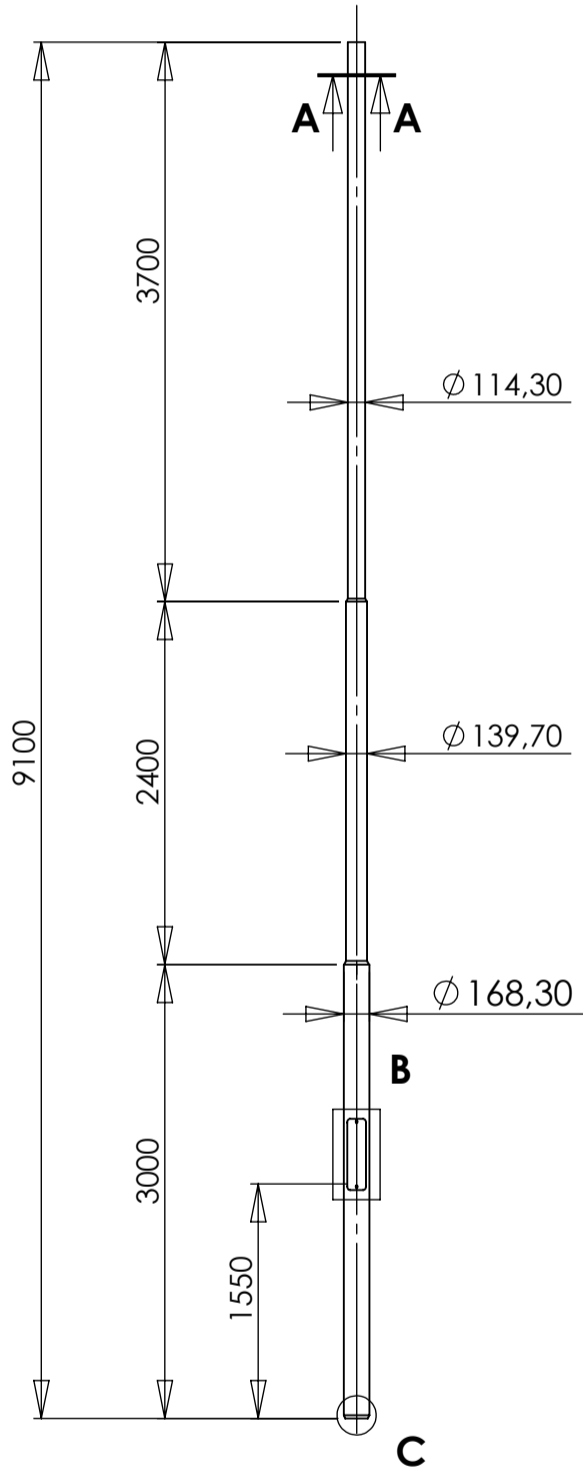
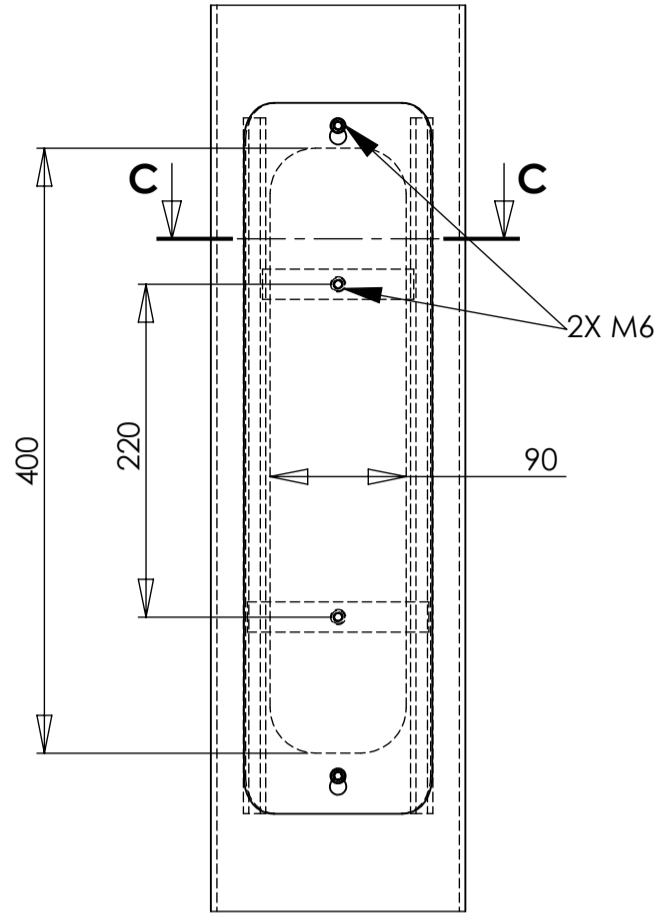

**SECTION C-C
SCALE 1 : 5**

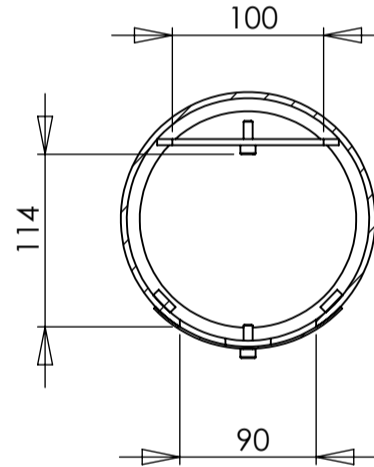

**DETAIL C
SCALE 1 : 5**

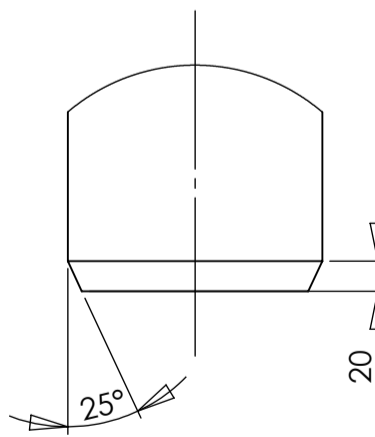

Raw Material = 114.39 kg
Area : 4,07 m²

REV	CREATED BY	DATE	DESCRIPTION	APPROVED BY	DATE
0	ta.maatta	4.5.2022	CREATE A LAYOUT	jo.innanen	4.5.2022
			Nikkarintie 4 FI-51200 Kangasniemi Finland Tel +358 15 337 7770 www.tehomet.com	THIS DRAWING IS PROPERTY OF VALMONT INDUSTRIES AND MUST NOT BE USED, COPIED OR PRODUCED WITHOUT VALMONT'S WRITTEN CONSENT	
MATERIAL :		CUSTOMER :		CALCULATION NUMBER :	PART NUMBER :
FINISH : GALV EN ISO 1461		B2100 4608208 OLAKERUNKO		DRAWING NUMBER :	REVISION
GENERAL TOLERANCE ± : EN40			A3	SCALE 1:50	110130KXXX B2100

SHEET :
1/1

D C B A